



ERZ  
母牙



ERZ.SST  
母牙



ERZ-P  
公牙



ERZ.SST-P  
公牙

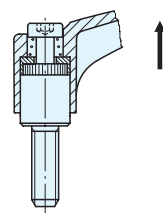
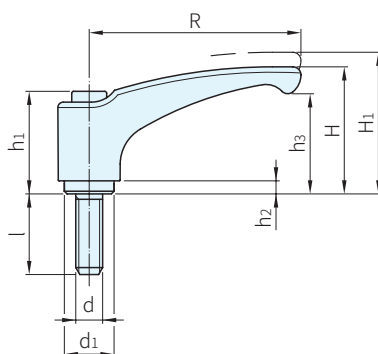
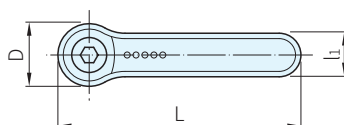
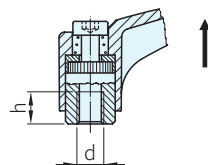
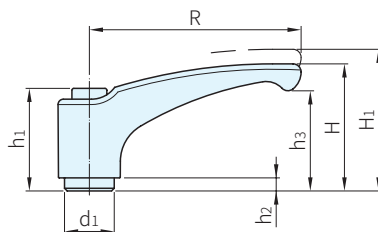
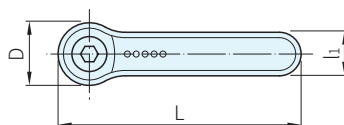

Type	把手		牙部	
	材質	顏色	材質	處理
ERZ	PA+玻纖	霧黑	SUM22L	染黑
ERZ-P				
ERZ.SST			SUS303	-
ERZ.SST-P				

Type	型式	R	d	L	D	H	H <sub>1</sub>	h	h <sub>1</sub>	h <sub>2</sub>	h <sub>3</sub>	d <sub>1</sub>	l <sub>1</sub>	齒數
ERZ (鋼, 母牙)	44A	44	M4	52.0	15.5	30.5	34.0	8	24.5	3.5	22.5	10.0	11.0	18
	44B		M5											
	44C		M6											
ERZ.SST (不銹鋼, 母牙)	63A	63	M6	73.5	19.0	38.5	42.0	10	31.0	3.5	30.0	13.5	13.5	24
	63B		M8											
	63C		M10											
ERZ-P (鋼, 公牙)	78A	78	M8	90.5	23.0	45.0	50.5	14	36.0	5.0	35.0	16.0	16.0	26
	78B		M10											
	78C		M12											
ERZ.SST-P (不銹鋼, 公牙)	95A	95	M10	109.0	26.5	56.5	61.5	17	43.0	5.0	45.0	19.0	18.0	28
	95B		M12											
	95C		M16											

鋼品號	庫存	不銹鋼品號	庫存	h	型式	質量(g)
ERZ-008	·	-		8	44A	16
ERZ-010	·	ERZ.SST-110	△		44B	16
ERZ-012	·	ERZ.SST-112	△		44C	15
ERZ-014	·	ERZ.SST-114	△	10	63A	36
ERZ-016	·	ERZ.SST-116	△		63B	34
ERZ-018	·	ERZ.SST-118	△	14	78A	61
ERZ-020	·	ERZ.SST-120	△		78B	55
ERZ-022	·	ERZ.SST-122	△	17	95A	93
ERZ-024	·	ERZ.SST-124	△		95B	86

**Sp. 特長**

- 把手曲線設計優美，手握觸感佳
- 把手位置上拉後可自由調整，放鬆後齒合復位

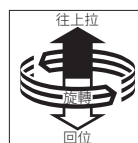

**Te. 技術資料**

- 使用溫度 max.130°C，min.-30°C

**Wa. 注意**

- 高溫及溼度大的環境下使用時，塑膠材料特性可能會產生劣化現象

鋼品號	庫存	不銹鋼品號	庫存	l	型式	質量(g)	鋼品號	庫存	不銹鋼品號	庫存	l	型式	質量(g)
ERZ-P-010	·	-		12	44A	15	ERZ-P-212	·	-		16	78A	70
ERZ-P-012	·	-		16		16	ERZ-P-214	·	-		20		72
ERZ-P-014	·	-		20		17	ERZ-P-216	·	-		25		75
ERZ-P-016	·	-		25		18	ERZ-P-218	·	-		32		79
ERZ-P-018	·	-		32		19	ERZ-P-220	·	-		40		83
ERZ-P-020	·	ERZ.SST-P-120	△	12	44B	17	ERZ-P-222	·	-		50	88	
ERZ-P-022	·	ERZ.SST-P-122	△	16		18	ERZ-P-224	·	-		63	94	
ERZ-P-024	·	ERZ.SST-P-124	△	20		19	ERZ-P-226	·	-		80	102	
ERZ-P-026	·	ERZ.SST-P-126	△	25		20	ERZ-P-228	·	-		16	72	
ERZ-P-028	·	ERZ.SST-P-128	△	32		21	ERZ-P-230	·	ERZ.SST-P-330	△	20	74	
ERZ-P-030	·	ERZ.SST-P-130	△	40	22	ERZ-P-232	·	ERZ.SST-P-332	△	25	77		
ERZ-P-032	·	ERZ.SST-P-132	△	50	23	ERZ-P-234	·	ERZ.SST-P-334	△	32	81		
ERZ-P-034	·	ERZ.SST-P-134	△	12	44C	19	ERZ-P-236	·	ERZ.SST-P-336	△	40	85	
ERZ-P-036	·	ERZ.SST-P-136	△	16		20	ERZ-P-238	·	ERZ.SST-P-338	△	50	90	
ERZ-P-038	·	ERZ.SST-P-138	△	20		21	ERZ-P-240	·	ERZ.SST-P-340	△	63	97	
ERZ-P-040	·	ERZ.SST-P-140	△	25		22	ERZ-P-242	·	ERZ.SST-P-342	△	80	106	
ERZ-P-042	·	ERZ.SST-P-142	△	32		23	ERZ-P-244	·	-		25	79	
ERZ-P-044	·	ERZ.SST-P-144	△	40	24	ERZ-P-246	·	-		32	83		
ERZ-P-046	·	ERZ.SST-P-146	△	50	25	ERZ-P-248	·	-		40	88		
ERZ-P-048	·	-		12	39	ERZ-P-250	·	-		50	94		
ERZ-P-050	·	ERZ.SST-P-150	△	16	40	ERZ-P-252	·	-		63	102		
ERZ-P-052	·	ERZ.SST-P-152	△	20	41	ERZ-P-254	·	-		80	112		
ERZ-P-054	·	ERZ.SST-P-154	△	25	42	ERZ-P-256	·	-		16	111		
ERZ-P-056	·	ERZ.SST-P-156	△	32	43	ERZ-P-258	·	ERZ.SST-P-358	△	20	113		
ERZ-P-058	·	ERZ.SST-P-158	△	40	44	ERZ-P-260	·	ERZ.SST-P-360	△	25	115		
ERZ-P-060	·	ERZ.SST-P-160	△	50	46	ERZ-P-262	·	ERZ.SST-P-362	△	32	118		
ERZ-P-062	·	ERZ.SST-P-162	△	63	48	ERZ-P-264	·	ERZ.SST-P-364	△	40	121		
ERZ-P-064	·	-		12	40	ERZ-P-266	·	ERZ.SST-P-366	△	50	128		
ERZ-P-066	·	ERZ.SST-P-166	△	16	41	ERZ-P-268	·	ERZ.SST-P-368	△	63	133		
ERZ-P-068	·	ERZ.SST-P-168	△	20	42	ERZ-P-270	·	ERZ.SST-P-370	△	80	141		
ERZ-P-070	·	ERZ.SST-P-170	△	25	43	ERZ-P-272	·	-		16	113		
ERZ-P-072	·	ERZ.SST-P-172	△	32	44	ERZ-P-274	·	ERZ.SST-P-374	△	20	117		
ERZ-P-074	·	ERZ.SST-P-174	△	40	46	ERZ-P-276	·	ERZ.SST-P-376	△	25	122		
ERZ-P-076	·	ERZ.SST-P-176	△	50	48	ERZ-P-278	·	ERZ.SST-P-378	△	32	125		
ERZ-P-078	·	ERZ.SST-P-178	△	63	50	ERZ-P-280	·	ERZ.SST-P-380	△	40	131		
ERZ-P-080	·	-		20	42	ERZ-P-282	·	ERZ.SST-P-382	△	50	138		
ERZ-P-082	·	-		25	43	ERZ-P-284	·	ERZ.SST-P-384	△	63	148		
ERZ-P-084	·	-		32	45	ERZ-P-286	·	ERZ.SST-P-386	△	80	160		
ERZ-P-086	·	-		40	47	ERZ-P-288	·	-		25	139		
ERZ-P-088	·	-		50	50	ERZ-P-290	·	-		32	146		
ERZ-P-090	·	-		63	53	ERZ-P-292	·	-		40	154		
ERZ-P-092	·	-		80	57	ERZ-P-294	·	-		50	171		
						ERZ-P-296	·	-		63	184		
						ERZ-P-298	·	-		80	199		

Ex. 使用例

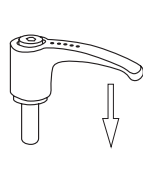
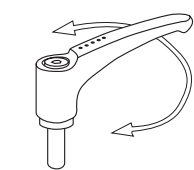
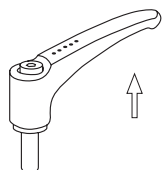

把手上拉，把手內部之咬合鋸齒分離

把手變成自由迴轉狀態，可以調整到任何位置

手放開，內藏式彈簧力下壓，回復咬合狀態(齒數24時， $360^\circ/24=15^\circ$ ，每15°咬合一齒)

訂貨：  交期：  天 ·  天 △  
ERZ-008