



ERX-P  
鋼



ERX.SST-P  
不銹鋼

Type	把手		押扣		入子		牙部		彈簧
	材質	顏色	材質	顏色	材質	顏色	材質	處理	材質
ERX-P	PA+玻纖	灰黑	工程塑膠	橘、黑	工程塑膠+玻纖	黑	鋼	鍍鋅	SUS302
ERX.SST-P							SUS303	-	

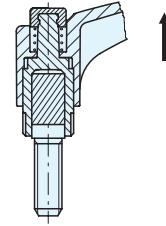
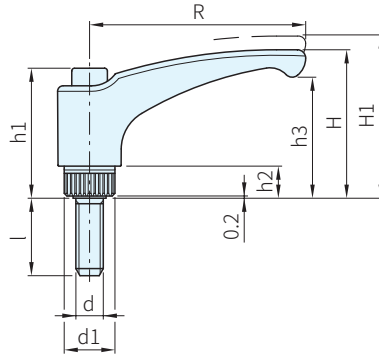
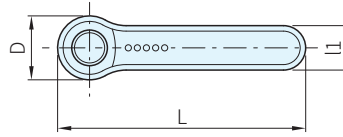

鋼 TYPE	不銹鋼 TYPE	NO. (中心蓋顏色)	R	d 6g	L	D	H	H1	h1	h2	h3	d1	l	l1	齒數	庫存 C2 其它		
ERX-P-210	-	C1 (黑色) C2 (橘色) C3 (灰色) C4 (黃色) C5 (藍色) C6 (紅色)	30	M5	37.5	15	30.0	33.5			23.0		10	9.0	18	•	△	
ERX-P-212	-			16									•			△		
ERX-P-214	-			20									•			△		
ERX-P-216	-			10									•			△		
ERX-P-218	ERX.SST-P-318			16									•			△		
ERX-P-220	ERX.SST-P-320			20									•			△		
ERX-P-222	ERX.SST-P-322		25	•	△													
ERX-P-224	ERX.SST-P-324		30	•	△													
ERX-P-226	-		29.5	6	12.0	40	•	△										
ERX-P-228	-		10	44	M5	52.0	16	32.5	36.0			25.0		10	11.0	20	•	△
ERX-P-230	-		16		•									△				
ERX-P-232	-		20		•									△				
ERX-P-234	ERX.SST-P-334		16		•									△				
ERX-P-236	-		20		•									△				
ERX-P-238	ERX.SST-P-338		25		•									△				
ERX-P-240	-		30	•	△													
ERX-P-242	-		40	•	△													
ERX-P-244	-		16	63	M6	72.5	19	43.0	47.0	37.5	8	34.5	15.0	16	13.5	20	•	△
ERX-P-246	-		20		•									△				
ERX-P-248	-		30		•									△				
ERX-P-250	ERX.SST-P-350		20		•									△				
ERX-P-252	-		25		•									△				
ERX-P-254	ERX.SST-P-354		30		•									△				
ERX-P-256	-		35	•	△													
ERX-P-258	-	40	•	△														
ERX-P-260	-	50	•	△														
ERX-P-262	-	60	•	△														

鋼 TYPE	不銹鋼 TYPE	NO. (中心蓋顏色)	R	d 6g	L	D	H	H1	h1	h2	h3	d1	l	l1	齒數	庫存 C2 其它													
ERX-P-264	ERX.SST-P-364	C1 (黑色) C2 (橘色) C3 (灰色) C4 (黃色) C5 (藍色) C6 (紅色)	78	M10	89.5	23	54.0	58.5	47.0	12	44.0	19.0	20	16.0	24	•	△												
ERX-P-268	-												25			•	△												
ERX-P-270	ERX.SST-P-370												30			•	△												
ERX-P-272	ERX.SST-P-372												40			•	△												
ERX-P-274	-												50			•	△												
ERX-P-276	-												60			•	△												
ERX-P-278	-			25									•			△													
ERX-P-280	ERX.SST-P-380			30									•			△													
ERX-P-282	ERX.SST-P-382			50									•			△													
ERX-P-284	ERX.SST-P-384			95									M12			108.0	26	64.5	69.0						30	18.0	26	•	△
ERX-P-286	ERX.SST-P-386																								50			•	△
ERX-P-288	ERX.SST-P-388																								30			•	△
-	ERX.SST-P-390		40		•	△																							
ERX-P-292	ERX.SST-P-392		50		•	△																							
ERX-P-294	ERX.SST-P-394		70		•	△																							
ERX-P-296	-		108	M12	123.0	30	65.5	70.0	54.5					30	20.0	28	•	△											
ERX-P-298	-													50			•	△											
ERX-P-410	-													70			•	△											
ERX-P-412	-			M14										11			52.5	25.0							30			•	△
ERX-P-414	-																								50			•	△
ERX-P-416	-																								70			•	△
ERX-P-416	-		M16										30												•			△	
ERX-P-414	-												50												•			△	
ERX-P-416	-												70												•			△	

**WA. 注意**

- 使用溫度MAX.130°C，MIN.-30°C
- 押扣的標準顏色是橘色，其它顏色包含黑色、灰色、黃色、藍色、紅色歡迎洽詢訂製
- 其它顏色押扣訂製品，最低訂貨數量是200PCS
- 交期、價格及品號請再向敝公司確認

訂貨： TYPE - NO. 交期： 1 天 ·  
ERX-P-210 - C2 12 天 △

**SP. 特長**

- 適用於因缺乏空間位置，旋轉角度受到限制的情況
- 完全電絕緣性
- 鋼件部分無外露，不會銹蝕
- 把手釋放更舒適
- 把手位置上拉後可自由調整，放鬆後齒合復位

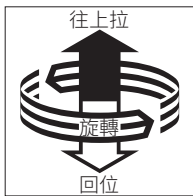

**TE. 技術資料**

- 鎖緊次數與鎖緊夾持力表：

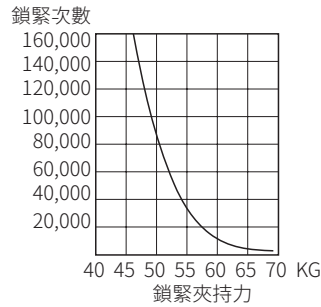

**EX. 使用例**

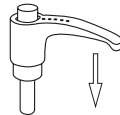
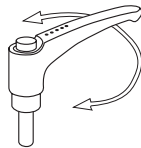
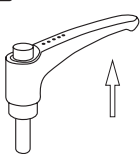

- 把手上拉，把手內部之咬合鋸齒分離
- 把手變成自由迴轉狀態，可以調整到任何位置
- 手放開，內藏式彈簧力下壓，回復咬合狀態(齒數18時，360°/18=20°，每20°咬合一齒)