



BRC15A0



BRC15LA

軌道	滑塊
材質	材質
軸承鋼	軸承鋼, 工程塑膠

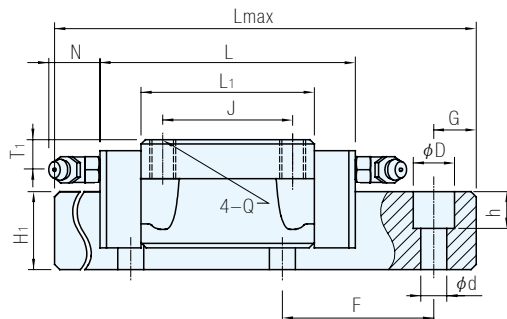
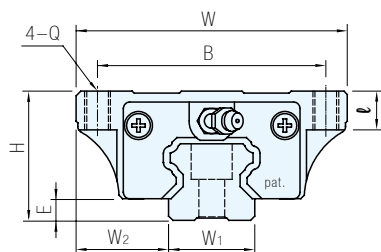

滑塊外形尺寸表

型號	組合尺寸				滑塊尺寸							滑軌尺寸			
	H	W	W <sub>2</sub>	E	L	B×J	Q×ℓ	L <sub>1</sub>	油孔	T <sub>1</sub>	(N)	W <sub>1</sub>	H <sub>1</sub>	F	d×D×h
BRC15A0	24	47	16	4.6	66	38×30	M5×8	40	φ3	4.3	5	15	14	60	4.5×7.5×5.8
BRD15A0					56										
BRC20A0	30	63	21.5	5	77.8	53×40	M6×9	48.8	M6×1	7	15.6	20	18	60	6×9.5×9.0
BRD20A0					67.8										
BRC20LA					92.4										
BRD20LA					82.4										
BRC25A0	36	70	23.5	7	88	57×45	M8×12	57	M6×1	7.8	15.6	23	22	60	7×11×9.5
BRD25A0					78										
BRC25LA					110.1										
BRD25LA					100.1										
BRC30A0	42	90	31	9	109	72×52	M10×12	72	M6×1	7	15.6	28	26	80	9×14×12.5
BRD30A0					99										
BRC30LA					131.3										
BRD30LA					121.3										
BRD35A0	48	100	33	9.5	109	82×62	M10×13	80	M6×1	8	15.6	34	29	80	9×14×12.5
BRD35LA					105.8										
BRD45A0	60	120	37.5	14	138.2	100×80	M12×15	105	M8×1	8.5	16	45	38	105	14×20×17.5
BRD45LA					163										

(滑軌+滑塊)

型號	滑塊				滑軌		精度等級	軌道數量*2
	法蘭型式	端蓋型式*5	滑塊數量	預壓	滑軌長度*1	指定單位1mm		
BRS15	A0(標準)*4	C(標準端蓋)	1	Z0 (零間隙)*3	80~4000	80(93)~4000	N(普通)	00(單軌) W2(2軌) ∴
BRS20			2					
BRS25	3							
BRS30	4	P(精密)						
BRS35	∴		110(132)~4000					
BRS45	LA(加長型)	D(短端蓋)	∴				110(135)~4000	

滑軌

型號	滑軌長度*1 指定單位1mm	精度等級
BRR15	80~4000	N(普通)
BRR20	80~4000	
BRR25	89~4000	
BRR30	110~4000	
BRR35	110~4000	
BRR45	139~4000	

Ps. 備註

- \*1 滑塊總長不能超過滑軌長度。( )內為法蘭型式LA尺寸
- \*2 在同一平面上使用多個直線導軌時,為滿足精度規格,請標明使用數量代碼
- \*3 預壓Z0為英文字母Z和數字0,其它預壓需求、預壓力參閱P.812
- \*4 法蘭型式A0為英文字母A和數字0
- \*5 端蓋型式C: 內部裝配自潤油棉; D: 內部無自潤油棉

型號	參考資料 (mm)		基本額定負荷 (kgf)		靜態容許力矩 (kgf·m)			質量	
	Lmax	G	(C)	(Co)	Mx	My	Mz	滑塊 (kg/個)	滑軌 (kg/m)
BRC15A0	4000	20	850	1350	10.1	6.8	6.8	0.21	1.4
BRD15A0									
BRC20A0	4000	20	1400	2400	24	14.6	14.6	0.4	2.6
BRD20A0									
BRC20LA			1650	3000	30	23.8	23.8	0.52	
BRD20LA									
BRC25A0	4000	20	1950	3200	36.8	22.8	22.8	0.57	3.6
BRD25A0									
BRC25LA			2600	4600	52.9	45.5	45.5	0.72	
BRD25LA									
BRC30A0	4000	20	2850	4800	67.2	43.2	43.2	1.1	5.2
BRD30A0									
BRC30LA			3600	6400	89.6	75.4	75.4	1.4	
BRD30LA									
BRD35A0	4000	20	3850	6200	105.4	62	62	1.6	7.2
BRD35LA			4800	8300	141.1	109.8	109.8	2	
BRD45A0			6500	10500	236.3	137.8	137.8	2.7	
BRD45LA	4000	22.5	7700	13000	292.5	210.9	210.9	3.6	12.3

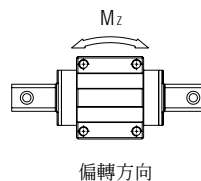
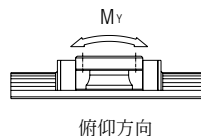
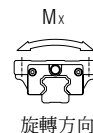

對端距G值的解說

如沒有特殊要求,則標準端距(G值)的計算方法如下:

滑軌總長度/滑軌安裝孔距=整數×孔距+餘數

餘數/2=端距

但是如果從端部到距其最近的安裝沉孔邊緣小於5mm,則增大其端距為(餘數+滑軌安裝孔距)/2=端距

例: BRS25-A0C2Z0-260N型直線滑軌

滑軌總長度=260,滑軌安裝孔距=60

滑軌總長度260/滑軌安裝孔距60=4×60+20

端距=20/2=10mm

但是,此滑軌沉孔直徑(D值)=11mm,因此其半徑=5.5mm

從滑軌端部到距其最近的安裝沉孔邊緣為10-5.5=4.5mm<5mm

則增大其端距為(20+60)/2=40mm,增大端距之後符合要求

預壓和精度基準

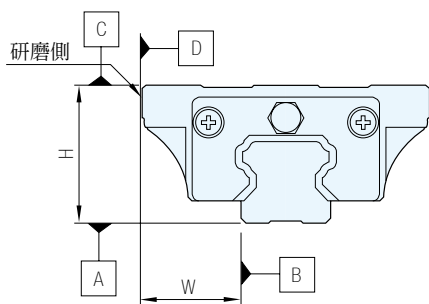

行走精度

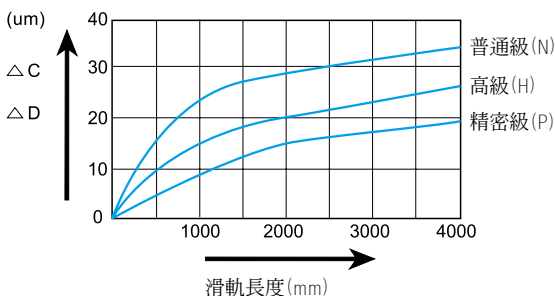

項目	精度等級		
	普通級 N	高級 H	精密級 P
高度H的尺寸容許誤差	±0.1	±0.04	0 -0.04
高度H的成對相互差(ΔH)	0.03	0.02	0.01
寬度W的尺寸容許誤差	±0.1	±0.04	0 -0.04
寬度W的成對相互差(ΔW)	0.03	0.02	0.01
滑塊C面對於滑軌A面的行走平行度	ΔC(如上圖)		
滑塊D面對於滑軌B面的行走平行度	ΔD(如上圖)		