

# UR 系列 空氣調理組合 – 調壓器

特點、規格表、訂購稱呼代號、內部結構圖、零件材料表

CHELIC

## 特點

- 壓力設定精確，穩定性高、變化量小
- 連接口徑最大可至 3/4
- 可與 U 系列產品連結作模組化使用



記號：



## 規格表

項目	型號	UR 200	UR 300	UR 400	UR 500
使用流體		空氣			
連接口徑	Rc	1/8, 1/4	1/4, 3/8	1/4, 3/8, 1/2	3/4
過濾精度	μm	5			
使用壓力範圍	kgf/cm <sup>2</sup> (kPa)	0.5 ~ 8.5 (50 ~ 850)			
最大使用壓力	kgf/cm <sup>2</sup> (kPa)	10 (1000)			
使用溫度範圍	°C	5 ~ 60			
材質	本體	鋁合金壓鑄品			
重量	kg	0.14	0.29	0.46	0.53

## 訂購稱呼代號

**UR 400 - 04 - G - P**



項目	記號	內容	型號			
			UR 200	UR 300	UR 400	UR 500
1 接管口徑	01	1/8	●	—	—	—
	02	1/4	●	●	●	—
	03	3/8	—	●	●	—
	04	1/2	—	—	●	—
	06	3/4	—	—	—	●
3 螺牙種類	無記號	RC	●	●	●	●
	G	PF	●	●	●	●
	N	NPT	●	●	●	●
4 壓力錶	無記號	方形壓力錶	●	●	●	●
	P	PG-10A 圓型壓力錶	●	●	●	●
	E	壓力傳感器 (PSN-41)	●	●	●	●

## 內部結構圖

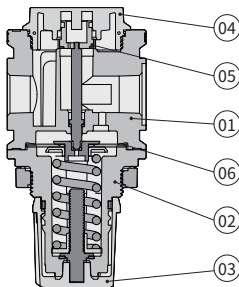

## 零件材料表

編號	項目	材質
01	本體	壓鑄鋁
02	調壓器座	POM
03	調壓旋鈕	ABS
04	下蓋	POM
05	閥門組	黃銅 + NBR
06	膜片	NBR

# UR 系列 空氣調理組合 – 調壓器

## 特性曲線圖

CHELIC

### 流量特性曲線圖

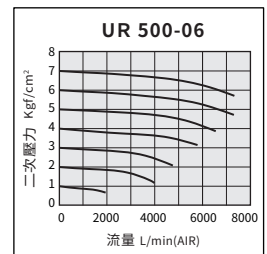
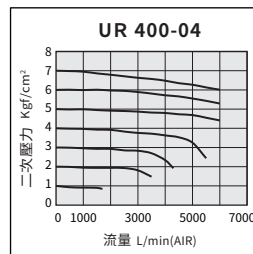
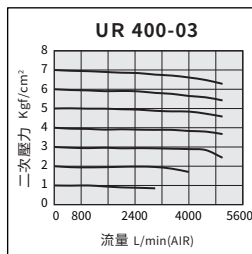
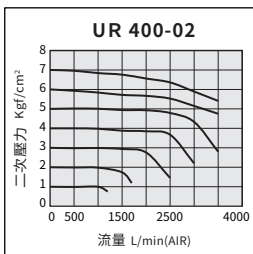
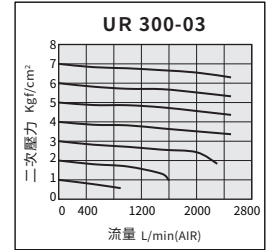
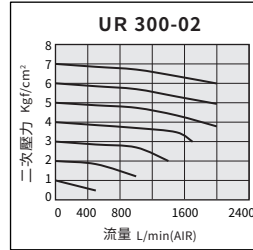
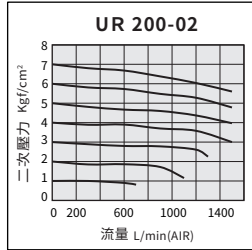
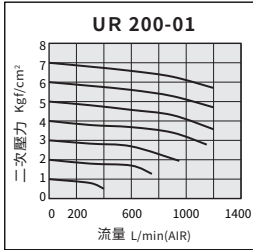

### 壓力特性曲線圖

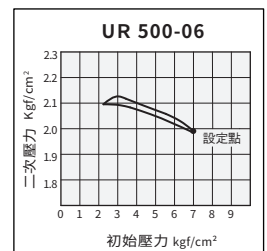
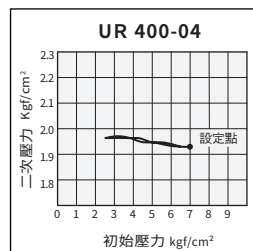
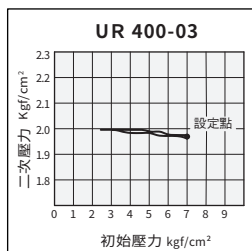
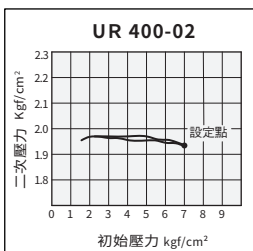
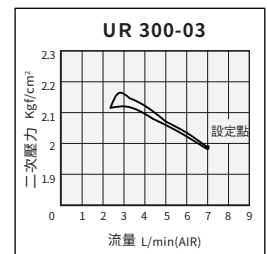
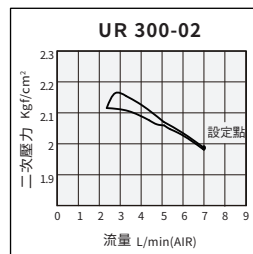
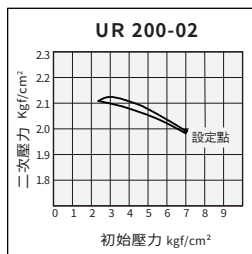
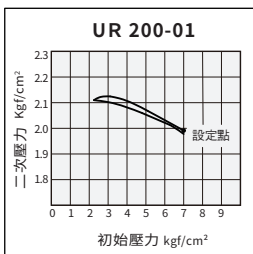

UC  
三點組合

UFC  
二點組合

UFR  
調壓過濾器

UF  
過濾器

UFM  
油霧分離器

UR  
調壓器

UL  
給油器

PN300D  
分歧塊

UES  
電控  
殘壓排放閥

UHS  
手動  
殘壓排放閥

UV  
緩和啟動閥

# UR 系列 空氣調理組合 — 調壓器

## 外觀尺寸圖

CHELIC

### UR 200

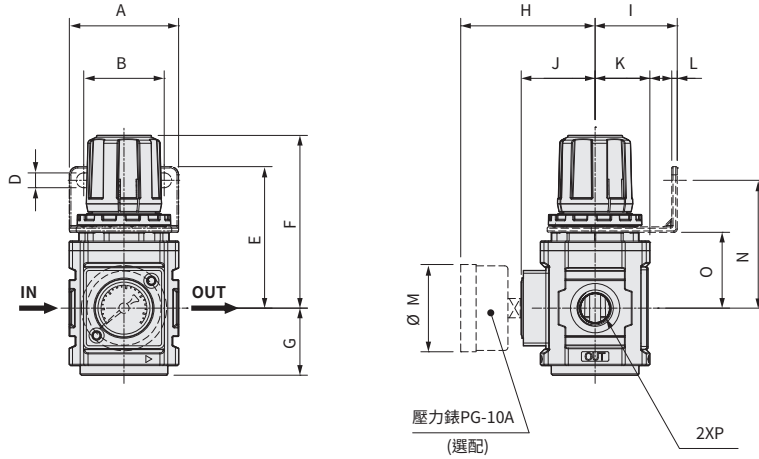

#### ● 面板固定尺寸

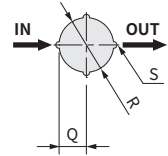

### UR 300 ~ 500

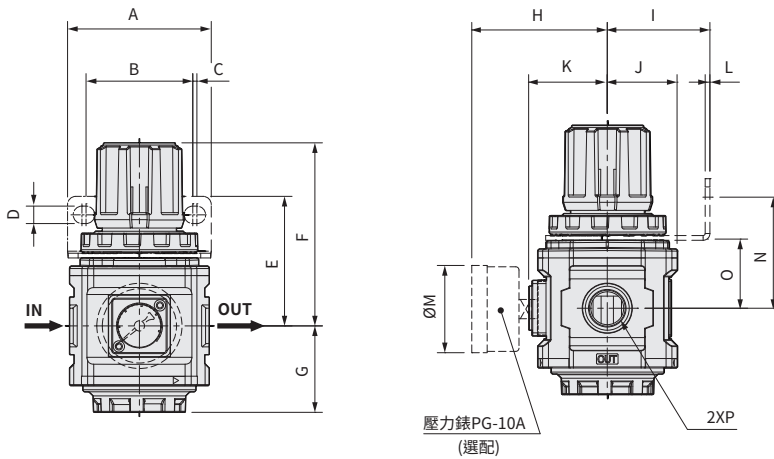

#### ● 面板固定尺寸

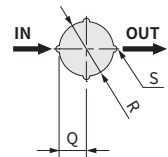

單位 :mm

記號 型式	A	B	C	D	E	F	G	H	I	J	L	ØM	N	O	方形壓力錶 K	壓力傳感器 K	面板固定尺寸			內孔牙徑
																	Q	ØR	ØS	P
UR 200	39.9	29.4		5.4	51.7	66.1	24.5	54.4	30	20	2	42.5	46.7	27.7	26.7	40.2	14.2	28.8	1.8	1/8, 1/4
UR 300	54	29.4	5.5	6.5	52.1	77.6	33.8	58.7	41.1	27	2	42.5	47.4	30	31	44.5	18	36.5	4.3	1/4, 3/8
UR 400	70	50	1	8.5	63.1	89.2	42.1	66	50	34	2.3	42.5	54.1	33.7	38.3	51.8	22.5	45.5	6	1/4, 3/8, 1/2
UR 500	72	50	1	8.5	64.2	92.2	45.2	66	50	34	2.3	42.5	56.2	36.2	38.3	51.8	22.5	45.5	6	3/4