

### ■ 防脫落

- 防止工件脫落或暴走時用之擋塊
- 和擋塊組合使用,也可達到簡易的位置定位
- 有防脫落機能線軌的螺絲

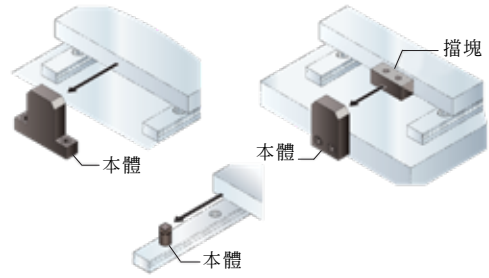

### ■ 位置定位用

- 和擋停螺絲與擋塊組合,可達到精密的位置調整
- 也有位置定位的固定銷孔

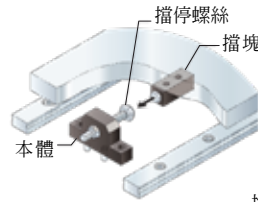

### ■ 小型化

- 小型化設計,在狹窄場所安裝最合適

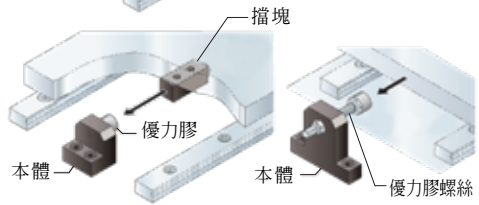

### ■ 擋塊

- 各式各樣的產品和安裝方式對應

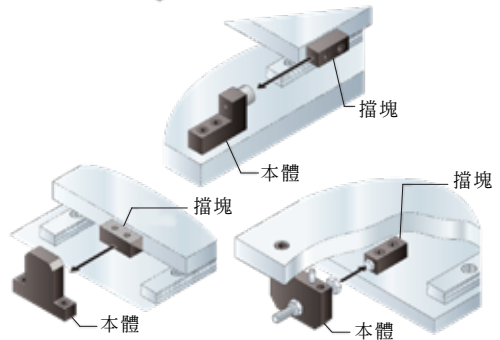

### ■ 擋停螺絲 · 優力膠螺絲 · 優力膠

- 可消除金屬間的撞擊音量
- 優力膠螺絲端部的優力膠可以拆卸更換
- 螺絲頭部淬火處理,尺寸種類齊全





### 止動螺絲型

- 以調整螺絲支撐作位置定位

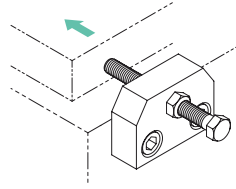

### 推拉型

- 調整螺絲前後移動作位置定位

### 專利

- 使用新方式的襯套，以市販螺絲來作前進後退即可。和舊方式使用特殊螺絲，其成本更便宜

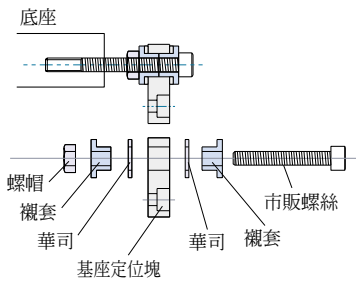
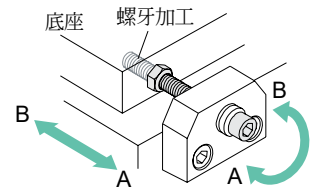

### 舊方式

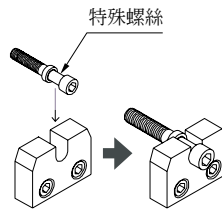

### 新方式

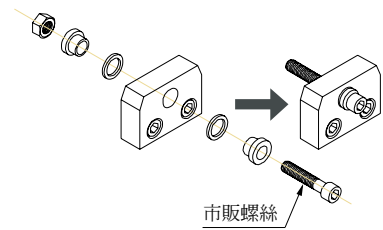



複合型

- 調整用和固定用的兩種螺絲並列型

專利

- 使用新方式的襯套,以市販螺絲來作前進後退即可。和舊方式使用特殊螺絲,其成本更便宜

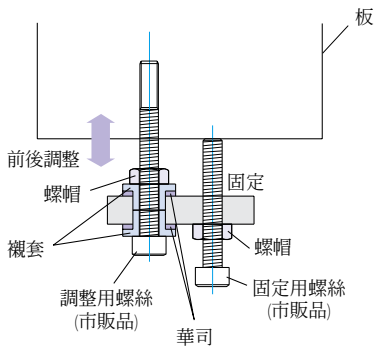
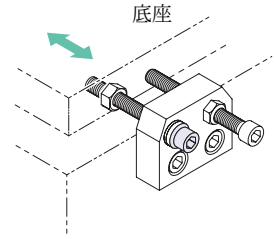

襯套

- 前進後退複合型的襯套和華司組合

推拉型

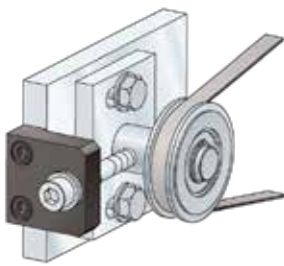

皮帶鬆緊調整

止動螺絲型

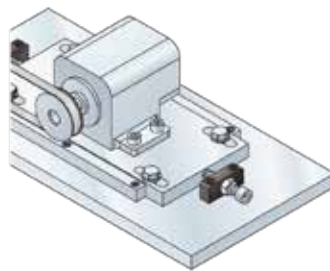

馬達底座定位

複合型

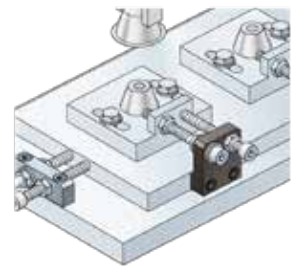

治具定位