

ROSTFRET
Inox Stainless Steel
IO-Link inside

- 3 Type**
- D** Pneumatically double-acting, protrude / retract
 - A** Pneumatically single-acting, retract by spring force
 - E** Pneumatically single-acting, protrude by spring force

- 4 Coding**
- OP** Without position query
BS0,4 Position query on both sides, with plug, cable 0.4 m

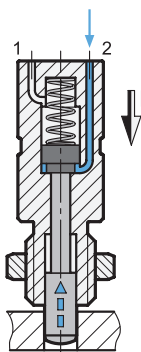
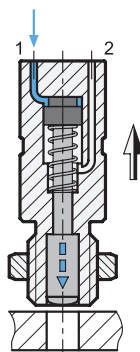
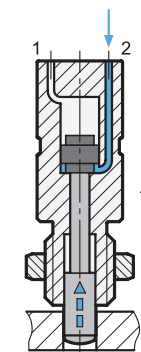
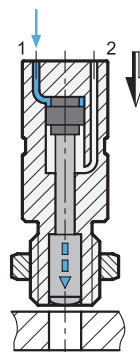
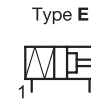
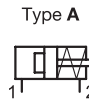
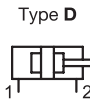

Retracted position

Protruding position

1 d_1 Pin -0.02 Bore H7	2 l_1	d_2	d_3	d_4	d_5	l_2	l_3	l_4	l_5	l_6 min.	A/F ₁	A/F ₂
6	9	M 12 x 1,5	M 3	21	2,6	73	22	10	24	4	19	18
8	12	M 16 x 1,5	M 3	21	2,6	76	26	10	24	4	19	24
10	12	M 16 x 1,5	M 3	21	2,6	76	26	10	24	4	19	24
12	15	M 20 x 1,5	M 3	21	2,6	76	34	10	24	4	19	30

Type D Force F at 6 bar in N ≈		Type A Spring force F in N ≈		Type E Spring force F in N ≈	
When protruding	When retracting	Retracted	Protruding	Retracted	Protruding
65	50	12	26	26	12

3.1
3.2
3.3
3.4
3.5
3.6
3.7
3.8
3.9



Specification

- Stainless steel AISI 303
Plunger pin surface hardened
- Rod seal
Polyurethane PUR
- Piston seal and O-ring
Acrylonitrile butadiene rubber (NBR)
- Magnet
Neodymium, iron, boron (NdFeB)
- Sensor
 - Housing
Polyamide (PA), black
 - Cable and plug
Outer sheath polyurethane (PUR), black
- Sensor clip
Polyacetal (POM), black
- Lock nut ISO 8675
Stainless steel, AISI 304
- *IP Protection Classes* → Page QVX
- *Load Rating Information* → Page QVX
- *ISO Fundamental Tolerances* → Page QVX
- *Elastomer Characteristics* → Page QVX
- *Stainless Steel Characteristics* → Page QVX
- **RoHS**

Accessory

- Cable with Connector GN 330
→ Page QVX

Information

Stainless steel indexing plungers GN 817.7 with pneumatic operation can be easily and securely integrated into automated processes and can be positioned at locations where hand operation of the indexing plunger is not possible. Thanks to the material used, the indexing plungers are also suitable for more aggressive environments.

An integrated magnet allows the plunger pin position to be queried electronically by a sensor. The end limits (protruding and retracted position) are taught-in via the operating element on the sensor cable. They each send a high signal, which is indicated by the respective LED and can be processed by a machine control, for example.

The sensor electronics can also be accessed via IO-Link and offer the ability to set and read out the switching points and to block the teach button on the operating element. To avoid interference, no external magnetic fields should act on the indexing plunger. The pneumatic indexing plungers are supplied with a lock nut. With coding BS0,4, the sensor, sensor clip and an allen wrench are also supplied loose.

see also...

- *List of Indexing Plunger Types* → Page QVX
- *Stainless Steel Indexing Plungers GN 717 (with Lifting Ring / with Wire Loop)* → Page QVX
- *Stainless Steel Indexing Plungers GN 722.4 / 5 / 6 (with Lifting Ring)* → Page QVX / QVX / QVX
- *Stainless Steel Indexing Plungers GN 817* → Page QVX
- *Stainless Steel Indexing Plungers GN 817.6 (with Sensor for Position Monitoring)* → Page QVX

How to order	1	d ₁
1 2 3 4	2	l ₁
GN817.7-10-12-D-BS0,4	3	Type
	4	Coding

Assembly Instructions

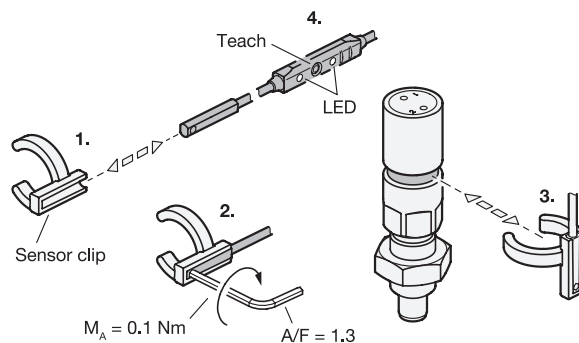



The radial position of the sensor cable can be freely determined when installing the sensor clip.

Installation steps:

1. Insert the sensor into the sensor clip from the side.
2. Tighten the hexagon socket screw of the sensor.
3. Clip the sensor clip into the ring groove of the indexing plunger and then adjust the position by turning, if necessary.
4. During commissioning, teach the sensor to the end positions via the operating element or IO-Link in accordance with the operating instructions supplied with the sensor.

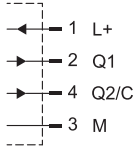
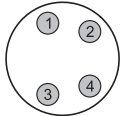
Pneumatic Properties	
Operating pressure	4 - 6 bar
Operating medium	Filtered, dried air, unoiled or oiled
Temperature range	-20 °C ... +80 °C

Electrical Properties of the Sensor		
Output function	2x normally open (NO)	
Output type	2x PNP	
Supply voltage	12 - 30 V DC	
Continuous current I_a	≤ 100 mA	
Connection type Plug (S)	4-pole connector M8x1, freely rotating with knurled screw connection	
Protection type	IP 67	
Power consumption	≤ 15 mA	
Voltage drop	≤ 2,2 V	
Protection class	III	
Temperature range	-20 °C ... +75 °C	
Shock and vibration resistance	30 g, 11 ms / 10 ... 55 Hz, 1 mm	
EMV	According to EN 60947-5-2	
Reverse polarity protection	Yes	
Short-circuit protection	Yes	
Activation impulse suppression	Yes	
Communication interface	IO-Link (V1.0) Cycle time 2.3 ms Process data length 2 bits Process data structure: Bit 0 = Switching signal Q_1 Bit 1 = Switching signal Q_2 Bit 2...7 = Empty	
Approvals, conformity declarations	 	

3.1

3.2

3.3

3.4

3.5

3.6

3.7

3.8

3.9

