

SPRING HINGE (DOUBLE ACTION) GS-DA

SUS

Passed 500,000 open/
close private cycle test

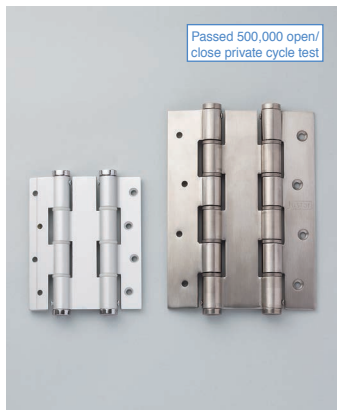

- Opens in both directions inside and outside.
- Spring loaded for self-closing.
- Spring tension adjustable with three steps with a hex key.
- Opening angle is 180°.
- All parts including shaft and spring made of stainless steel (SUS304).

[Relationship Between Door Height and Door Weight]

	GS-DA120	GS-DA180
Recommended Door Height	1800~2500 mm	
Min. Door Height	500 mm	800 mm
Door Weight	Door Height: Max. 1800mm	
	Reduce by 1.1 kg for lowering 100mm each time.	Reduce by 2.1kg for lowering 100mm each time.

[Remarks]

- In case of noise, apply lubricant (grease) to washer and torsion spring.

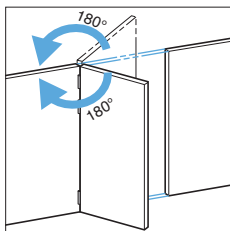

Hinges for double action door.

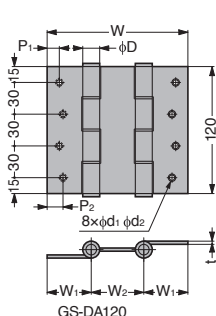

GS-DA120

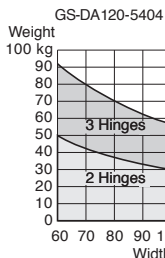
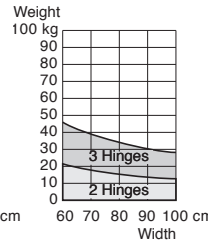
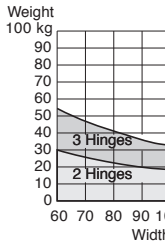

GS-DA120-5404

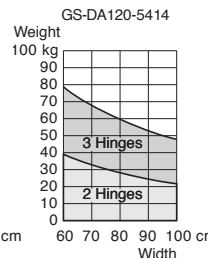

GS-DA120-5414

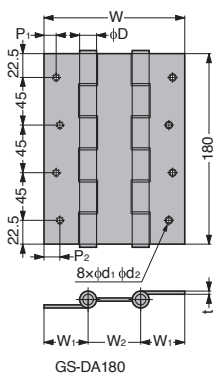

GS-DA180

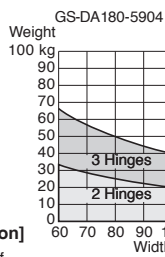

GS-DA180-5904

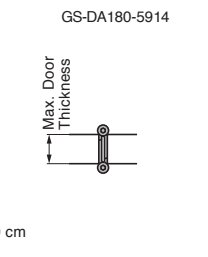

GS-DA180-5914

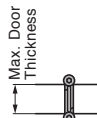

[Installation]

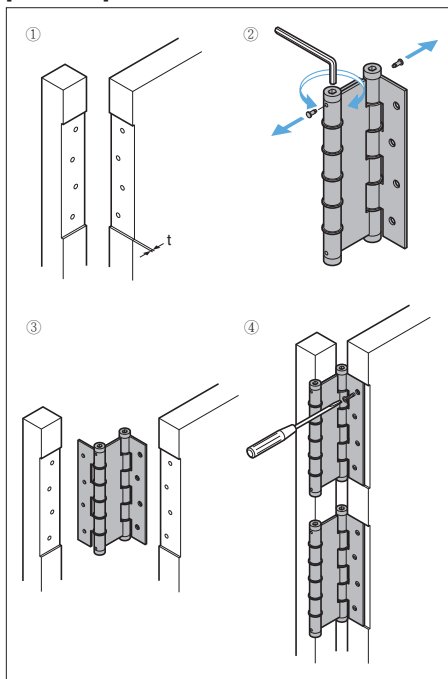

[How to Adjust Spring Tension]

- Figure below shows the case of left-hanging.

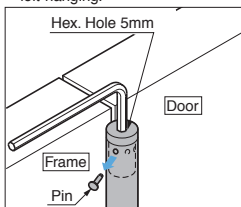

Loosen shaft with a hex key and remove the pin.

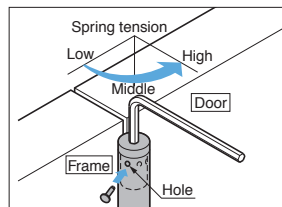

Adjust spring tension with three steps. Put the pin to the hole and fix.

Item Name	Material	Finish	W	W ₁	W ₂	P ₁	P ₂	D	t	d ₁	d ₂	Max. Door Thickness	Opening Angle	Screw	Weight (g)	
GS-DA120-5404-01	Aluminium Alloy	Anodised	101	29.5	42	6.5	11.5	16	4	5.3	10	30	180°	-	275	
GS-DA120-5414-01			133	40	53	11	16	16	4	5.3	10	40			320	
GS-DA120-5414-05	Stainless Steel (SUS304)	Plain	17	2.5	5.5	9	36	Countersunk Head Tapping Screw	555							
GS-DA180-5904-01	Aluminium Alloy	Anodised	101	29.5	42	6.5	11.5	16	4	5.3	10	30		180°	-	407
GS-DA180-5914-01			133	40	53	11	16	16	4	5.3	10	40				466
GS-DA180-5914-05	Stainless Steel (SUS304)	Plain	18	3	5.5	9	38	Countersunk Head Tapping Screw	947							
GS-DA180-5934-01	Aluminium Alloy	Anodised	157	48.5	60	19.5	24.5	16	4	5.3	10	50	Tapping Screw		510	