

- > Port size: G1/8 & G1/4
- > Very compact unit
- > Universal useable



### Technical features

**Medium:**

Compressed air only

**Maximum inlet pressure:**

20 bar (290 psi)

**Pressure range:**

 0,3 ... 7 bar (4 ... 101 psi),  
 0,3 ... 3,5 bar (4 ... 50 psi),  
 0,1 ... 0,7 bar (1 ... 10 psi),  
 0,3 ... 10 bar (4 ... 145 psi)

**Flow:**

see below

**Port sizes:**

 G1/8 or G1/4  
 Rc1/8 (Gauge)

**Ambient/Media temperature:**

-34 ... +65°C (-29 ... +149°F)

 Air supply must be dry enough to  
 avoid ice formation at temperatures  
 below +2°C (+35°F)

**Materials:**

Body: Zinc alloy

Bonnet and knob: Acetal

Valve: Brass

Seals: NBR

### Technical data, standard models with relieving

Symbol	Port size	Pressure range (bar)	Flow *1) (dm <sup>3</sup> /s)	Weight (kg)	Model
	G1/8	0,3 ... 7	6,5	0,19	R07-100-RNKG
	G1/4	0,3 ... 7	7	0,19	R07-200-RNKG

\*1) Flow at inlet pressure 10 bar (145 psi), outlet pressure 6,3 bar (91 psi) and pressure drop 1 bar (14 psi)

### Option selector

Port size	Substitute
1/8"	1
1/4"	2
Option	Substitute
Standard	0
Pressure range 10 bar	5

**R07-★0★-★★★★**

Thread	Substitute
PTF	A
ISO G	G
Pressure range (bar) *1)	Substitute
0,1 ... 0,7	A
0,3 ... 3,5	E
0,3 ... 7	K
0,3 ... 10	M *2)
Gauge	Substitute
Wi h	G
Wi hout	N
Diaphragm	Substitute
Relieving	R
Non-relieving	N

\*1) Outlet pressure can be adjusted to pressures in excess of and less than, those specified. Do not use these units to control pressures outside of the specified ranges.

\*2) When specifying 10 bar (145 psi) unit, eg. R07-205-RNMG, also note correct code at 6th digit.

**Flow characteristics**

Port size 1/4", Pressure range 0,3 ... 7 bar

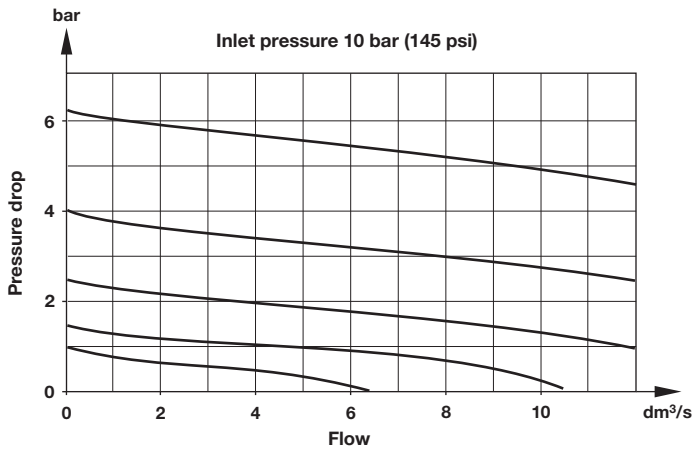





**Accessories**



**Service kit**



Wall mounting bracket and panel nut	Panel nut	Tamper resistant field modification	Gauge ø 40 mm
			
<b>1 &amp; 4</b>	<b>4</b>	<b>3</b>	<b>6</b>
18-025-003 (with plastic nut) 18-025-004 (with metal nut)	2962-04 (Metal) 2962-89 (Plastic)	18-001-092	18-013-990 (0 ... 4 bar) 18-013-989 (0 ... 10 bar (145 psi))

**Dimensions**
**Bracket mounting**

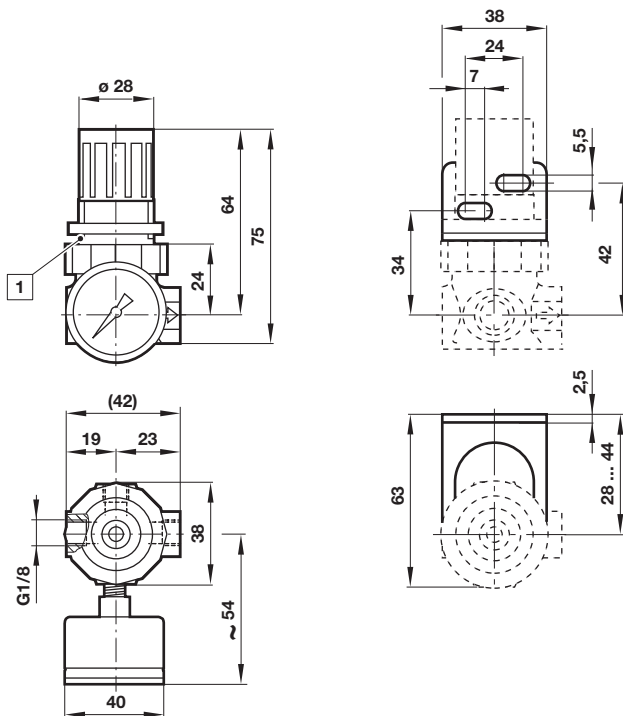
 Dimensions in mm  
 Projection/First angle

 1 Panel mounting hole  $\varnothing$  31 mm

**Warning**

These products are intended for use in industrial compressed air systems only. Do not use these products where pressures and temperatures can exceed those listed under

**»Technical features/data«.**

Before using these products with fluids other than those specified, for non-industrial applications, life-support systems or other applications not within published specifications, consult IMI NORGREN.

Through misuse, age, or malfunction, components used in fluid power systems can fail in various modes.

The system designer is warned to consider the failure modes of all component parts used in fluid power systems and to provide adequate safeguards to prevent personal injury or damage to equipment in the event of such failure.

System designers must provide a warning to end users in the system instructional manual if protection against a failure mode cannot be adequately provided.

System designers and end users are cautioned to review specific warnings found in instruction sheets packed and shipped with these products.